

Technical data sheet

Cable gland with locknut as a set

Item number: 7205663



Robust cap nut cable gland with metric connecting thread to IEC 423, including pre-mounted locknut.

For high tightness requirements. Strain relief, torsion protection and tightness over the whole clamping area. Sealing ring made of polychloroprene/acrylonitrile butadiene rubber. Moulded shaped sealing lip on intermediate support, no connection thread sealing ring required.

VDE-tested according to DIN EN 50262, protection rating IP68 at 5 bar for 1 hr.

For maintenance of electrical function according to DIN 4102 Part 12 in connection with the closed junction boxes of the FireBox T series.

Colour: Pastel orange.

PA Polyamide

Master data

| | |
|---------------------|-------------------------|
| Item number | 7205663 |
| Type | V-TEC VM25+ OR |
| Description 1 | Cable gland |
| Description 2 | with locknut |
| Manufacturer | OBO |
| Dimension | M25 |
| Colour | Pastel orange; RAL 2003 |
| Material | Polyamide |
| Smallest sales unit | 10 |
| Unit of quantity | Piece |
| Weight | 1.71 kg |
| Weight unit | kg/100 pc. |

Technical data sheet

Cable gland with locknut as a set



Item number: 7205663

Dimensions

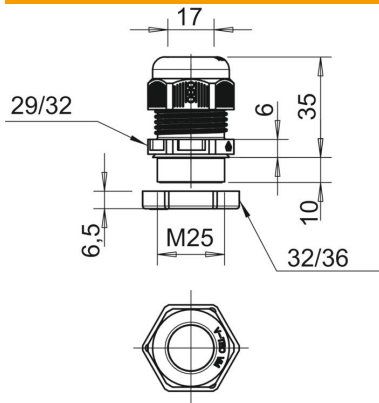

| | |
|-------------------|--------------|
| Dimension E | 32 mm |
| Dimension E1 (mm) | 32 mm |
| Dimension E2 | 36 mm |
| Dimension G | M25 x 1,5 mm |
| Dimension L max. | 35 mm |
| Dimension L min. | 26 mm |
| Dimension L1 | 10 mm |
| Dimension L2 | 6 mm |
| Dimension L3 | 6.5 mm |

Technical data

| | |
|-----------------------------------|---|
| Bend protection | no |
| Sealing area D, max. | 17 mm |
| Sealing area D, min. | 9 mm |
| Flat cable gland | no |
| Flame-resistant | acc. to VDE 0471/DIN 695 Part 2-1, test temperature 650°C |
| For Ex zone | Without |
| For Ex zone gas | Without |
| For Ex zone dust | Without |
| Thread | M25 x 1,5 |
| Thread type | Metric |
| Thread length | 10 mm |
| Thread increase | 1.5 mm |
| Fibre-glass reinforced | no |
| Halogen-free | yes |
| Unstable torque | 5 Nm |
| Sealing insert, multiple | no |
| With locknut | yes |
| Impact-resistant | no |
| WAF | 29 |
| WAF 1 | 29 mm |
| WAF 2 | 32 mm |
| Protection rating | IP68 |
| Splittable gland | no |
| Permitted temperature range, max. | 65 °C |
| Permitted temperature range, min. | -20 °C |
| Strain relief option | yes |