

Technical data sheet

Cable ladder SSP150 Nema 20C, 6 m

Item number: 6905365



Heavy-duty SSP150 cable ladder system, welded version. The side height is 150 mm with a supply length of 6000 mm.
Magnetic shield insulation without cover 10 dB, with cover 15 dB.

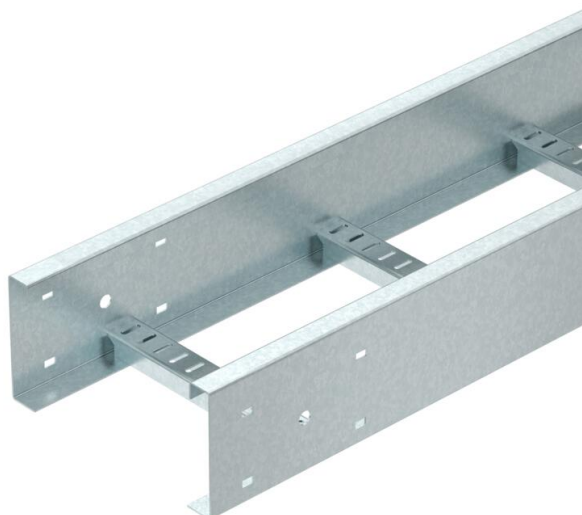

St Steel

FT Hot-dip galvanised

Master data

Item number	6905365
Type	SSP150 500 HDG
Description 1	Cable ladder
Description 2	SSP150 Nema 20B
Manufacturer	O-line
Dimension	6000x500x150
Material	Steel
Surface	Hot-dip galvanised
Surface standard	DIN EN ISO 1461
Smallest sales unit	6
Unit of quantity	Metre
Weight	983.67 kg
Weight unit	kg/100 m

Dimensions

Length	6,000 mm
Length	6,000 ft
Width	500 mm
Height	150 mm
Dimension B	500 mm

Technical data sheet

Cable ladder SSP150 Nema 20C, 6 m

Item number: 6905365



Technical data

Rung distance	300 mm
Rail thickness	2 mm

Loads

Support spacing 5.0 m	2 kN/m
Support spacing 6.0 m	1.6 kN/m
Support spacing 7.0 m	1.3 kN/m
Support spacing 8.0 m	1 kN/m

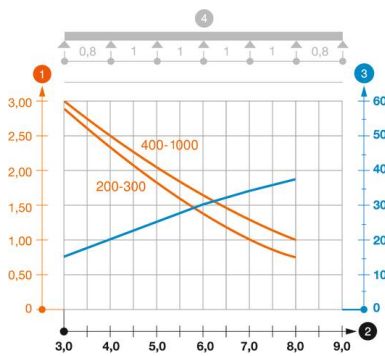

Load diagram, wide span cable ladder, type SSP150 Nema 20B

- 1 Permitted cable tray/ladder load in kN/m without man load
- 2 Support width in m
- 3 Rail bend in mm at permitted kN/m
- 4 Load scheme during testing
- Load curve with cable tray/ladder width in mm
- Strut bend curve according to support width