

Technical data sheet

Cable-pipe clip OLTC NAA

Item number: 1500648



Fastening clip with retaining plate to accept 3 cables or pipes.
Complete with bolts, nuts, washers and head plates.



CE

Alu Aluminium

Master data

Item number	1500648
Type	OLTC02/48 NAA
Description 1	Cable and pipe clip
Description 2	48 mm
Manufacturer	O-line
Dimension	195x95x40
Material	Aluminium
Smallest sales unit	1
Unit of quantity	Piece
Weight	24.2 kg
Weight unit	kg/100 pc.

Technical data sheet

Cable-pipe clip OLTC NAA

Item number: 1500648



Dimensions

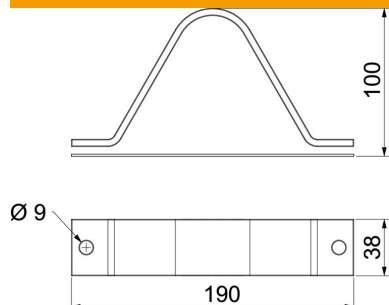

Dimension A	170 mm
Dimension B	93 mm

Technical data

For diameter	48
--------------	----