

Technical data sheet

Cable-pipe clip OLTC HDG

Item number: 1500575



Fastening clip with retaining plate to accept 3 cables or pipes.
Complete with bolts, nuts, washers and head plates.



St Steel

FT Hot-dip galvanised

Master data

Item number	1500575
Type	OLTC01/75 HDG
Description 1	Cable and pipe clip
Description 2	70-75 mm
Manufacturer	O-line
Dimension	240x40x45
Material	Steel
Surface	Hot-dip galvanised
Surface standard	DIN EN ISO 1461
Smallest sales unit	1
Unit of quantity	Piece
Weight	44.8 kg
Weight unit	kg/100 pc.

Technical data sheet

Cable-pipe clip OLTC HDG

Item number: 1500575



Dimensions

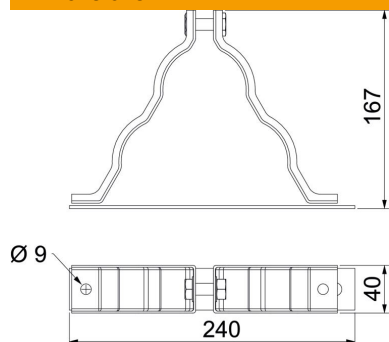

Dimension B	162 mm
-------------	--------

Technical data

For diameter	70-75
Clamping range D, max.	210 mm
Clamping range D, min.	170 mm