

Technical data sheet

Central hanger for cable tray, side height 60 mm FS

Item number: 6358705



Centre suspension for cable trays with rolled side rail of side height 60 mm. The centre suspension possesses a rotatable M10 threaded sleeve. When filling, ensure an even distribution of the load (avoid one-sided filling).

The widths 100, 150 and 200 mm have additional base perforations, in order to screw the centre suspensions to the tray base when used for the maintenance of electrical functionality according to DIN 4102 Part 12.

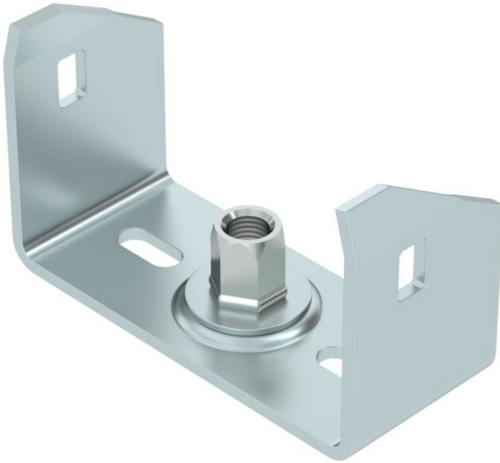

St Steel

FS Strip galvanized

Master data

Item number	6358705
Description 1	Centre suspension
Description 2	for cable tray
Manufacturer	OBO
Dimension	B100mm
Material	Steel
Surface	Strip galvanized
Surface standard	DIN EN 10346
Smallest sales unit	1
Unit of quantity	Piece
Weight	17.25 kg
Weight unit	kg/100 pc.

Technical data sheet

Central hanger for cable tray, side height 60 mm FS



Item number: 6358705

Dimensions

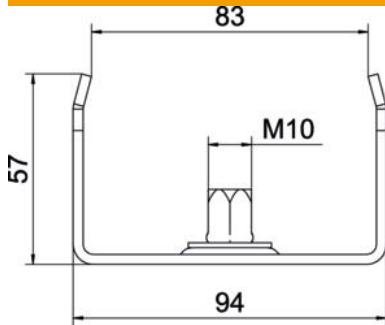

Length	40 mm
Width	100 mm
Width	4 in
Height	57 mm
Dimension B	94 mm
Dimension b	84 mm
Dimension B1	84 mm

Technical data

Version for	Suspended
F in kN	1.3 kN
Maintain electrical functions	yes
for width max.	100 mm
for width min.	100
Suitable for metric threaded rod	10
Suitable for mesh cable tray	no
Suitable for cable ladder	no
Suitable for cable tray	yes
Suitable for tray/ladder width	100 mm
Hole diameter	10.5 mm
Adjustable	no