

Technical data sheet

Clamp clip 2056 F-foot, 1-fold, metal pressure sleeve, FT

Item number: 1187426



Clamp clip with F-foot, metal pressure sleeve with rounded edges to protect the cable. For vertical and horizontal mounting of 1 single cable on flat bars. With 1-start screw thread on pressure sleeve, universal hexagonal screw head WAF10, with slot and cross recess. Suitable for assembly indoors and outdoors. We recommend the use of a counter-sleeve.



St Steel

FT Hot-dip galvanised

Master data

Item number	1187426
Type	BS-F1-M-34 FT
Description 1	Clamp clip 2056
Manufacturer	OBO
Dimension	28-34mm
Material	Steel
Surface	Hot-dip galvanised
Surface standard	DIN EN ISO 1461
Smallest sales unit	100
Unit of quantity	Piece
Weight	8 kg
Weight unit	kg/100 pc.

Technical data sheet

Clamp clip 2056 F-foot, 1-fold, metal pressure sleeve, FT



Item number: 1187426

Dimensions

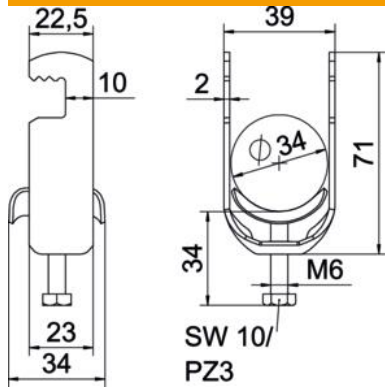

Length	22.5 mm
Width	39 mm
Height	71 mm
Plate thickness	2 mm
Dimension A	22.5 mm
Dimension B	39 mm
Dimension C	34 mm
Dimension G (mm)	M6
Dimension H	71 mm
Dimension L	34 mm
Dimension t	2 mm

Technical data

Number of cables/pipes	1
For pipe diameter, max.	34 mm
For pipe diameter, min.	28 mm
Thread	M6
Halogen-free	yes
Length of external dimensions	34 mm
Max. Tightening torque	3 Nm
With metal trough	yes
Mounting type	Flat profile
Slot width	10 mm
Clamping range D, max.	34 mm
Clamping range D, min.	28 mm
Surface addition	hot galvanised
Material addition	Steel
With counter-trough	no
Material of trough	Steel